

M8-Rod end

- self-adjusting rod end
- tension accessory
- ensures the correct load introduction
- low-maintenance
- static load rating max 100000.

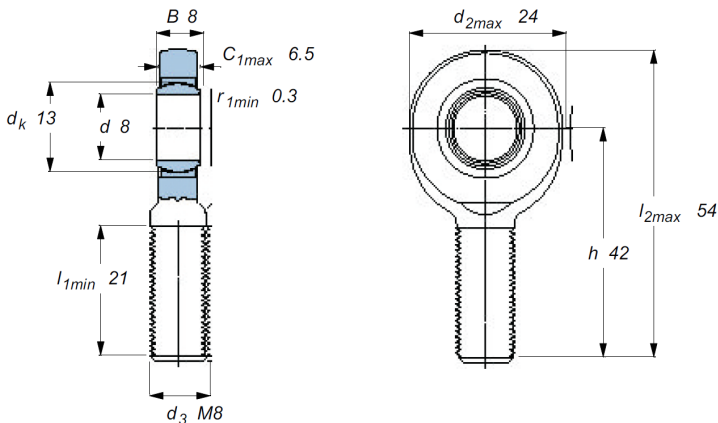

measurements

d	=	10 mm.
d2	=	24 mm
d3	=	M8
B	=	8 mm
C1	=	6,5 mm
h	=	42 mm



Max. angle 15°

Static load rating max 10000 N

Dynamic load rating max 5800 N

For applications where a lot of changing forces occur because the angle of the forces, are periodically changed, it is necessary to bypass (bypass) the spherical heads with a safety system